















MRT 1440 *EASY*

-  **Lift capacity**4000 kg
(on stabilisers) at 500 mm from forks heels
-  **Lift height**13,80 m
-  **Tyres**
400/70 - 20 14 PR
-  **Forks (mm)**
Length1200
Width x thickness150 x 50
-  **Multidisc brakes**
Hydraulically assisted on front axle
Negative parking brake
-  **Engine PERKINS Euro 3**
Type1104D-E44 T
Capacity4 cyl. - 4400 cm³
Power (ISO/TR 14396)101 HP/74,5 kw
at 2200 rpm
Maximum torque392 Nm at 1400 rpm
Water cooling
Direct injection
-  **Transmission** hydrostatic with automatic power
regulation (variable displacement pump and motor)
with control inching
Reversing shiftelectromagnetic
Speed forward and reverse2/2
Travel speed35 km/h
-  **Rear axle**
Automatic rear axle locking system
at a rotation over 5°
-  **4 stabilisers**
simultaneous or individually controlled
-  **Rotation through 400° (Optional 360° continuous
rotation)**
Turret mounted on a double slew ring
Slewing system with negative brake
-  **Hydraulics**
2 pumps gear type270 bars/115 l/mn
-  **Control** : 2 proportional control joysticks for all hydraulic
movements
-  **Capacities**
Cooling system25 l.
Engine oil8,1 l.
Hydraulic oil150 l.
Fuel tank130 l.
-  **Weight unladen (with forks)**12450 kg
Overall **width**2,39 m
Overall **height**2,94 m
Length (forks carriage)5,33 m
Ground clearance0,32 m
Drawbar pull8600 daN
-  **Safety**
Standard load moment indicator
(mobile crane standards)

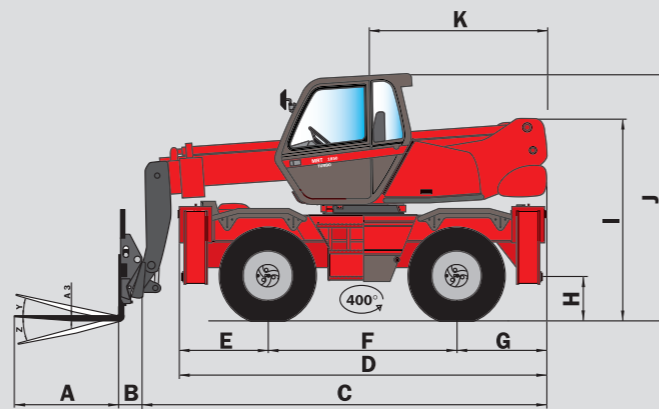

A	1200
A1	150
A2	1320
A3	50
B	290
C	5044
D	4290
E	980
F	2320
G	990
H	320
I	2340
J	2940
K	2040
L	1930
M	2390
N	3718
O	3977
P	210
Q	3900
R	3410
S	4000
V	950
Y	12°
Z	105°

mm

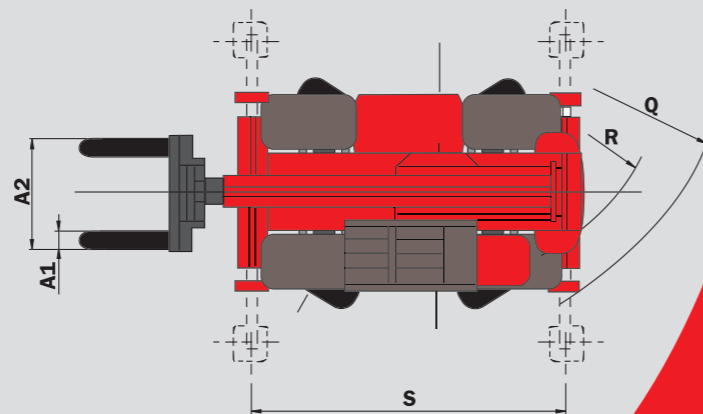
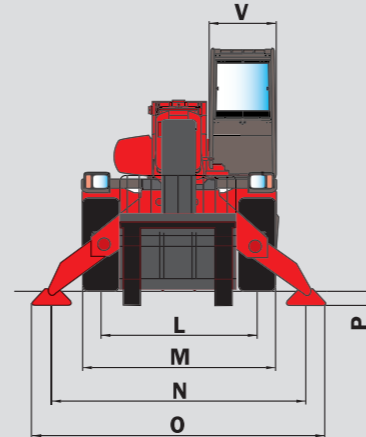

MANISCOPIC

MRT 1440

EASY

- Lift height : 13,80 m
- Max. reach : 11,50 m
- Engine : 101 cv - 74,5 kw
- 4 wheel drive - 4 wheel steer
- Hydrostatic transmission



This publication in no way constitutes an offer and the company reserves the right to alter specification without prior notice. The MANITOU models presented in this brochure can be supplied complete with optional equipment attachments.



MRT 1440



ROTATION ON STABILISERS WITH FORKS

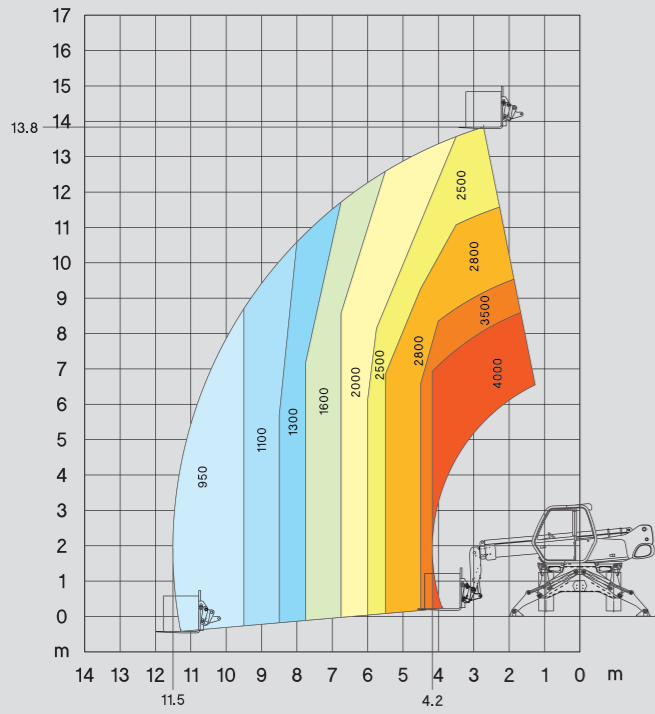

FRONTAL POSITION ON WHEELS WITH FORKS

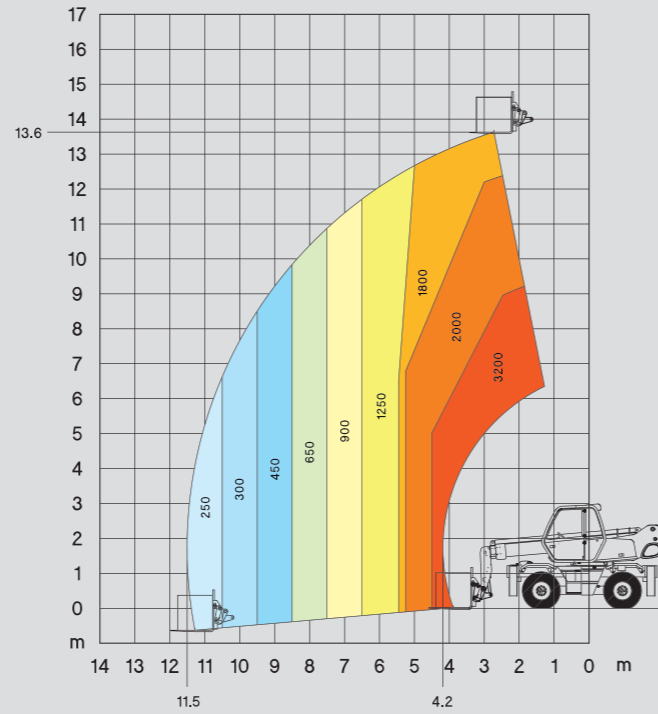

ROTATION ON STABILISERS WITH JIB P 600

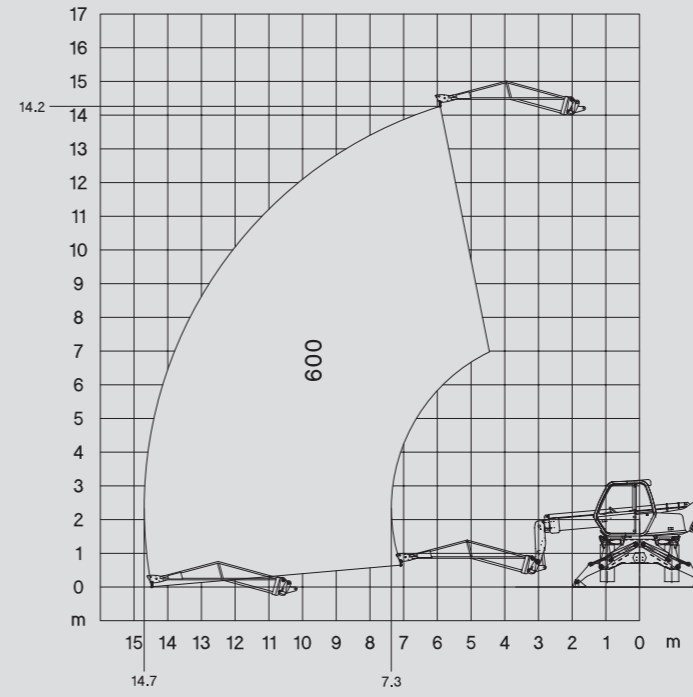

ROTATION ON STABILISERS WITH JIB P 1500

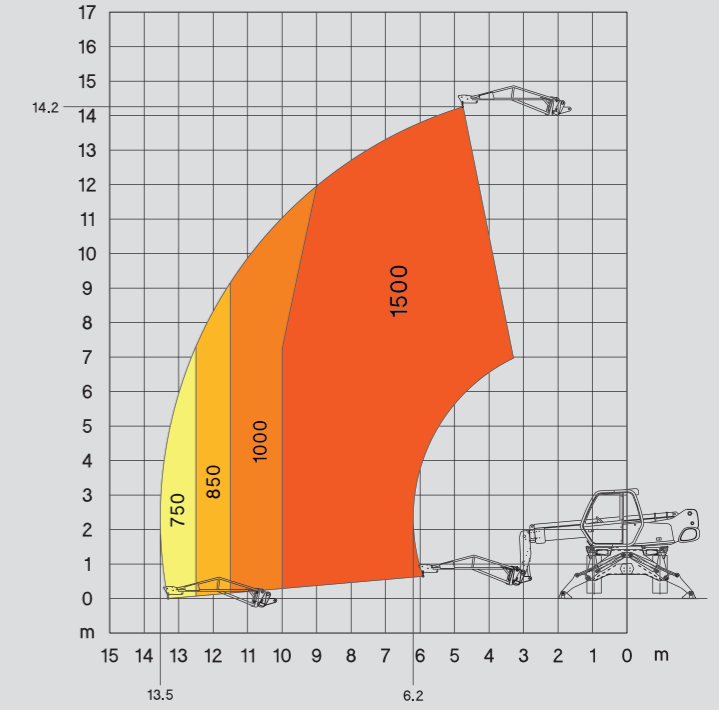

ROTATION ON WHEELS WITH FORKS

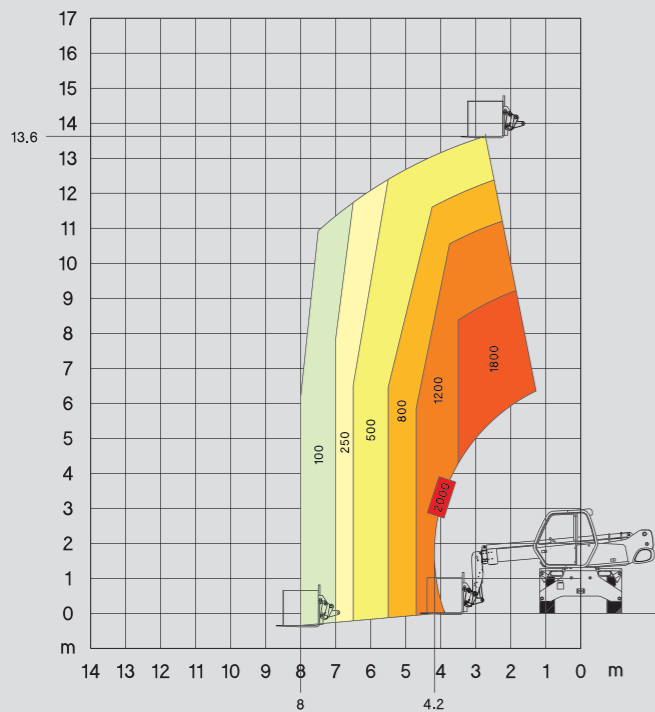

ROTATION ON STABILISERS WITH 3T WINCH

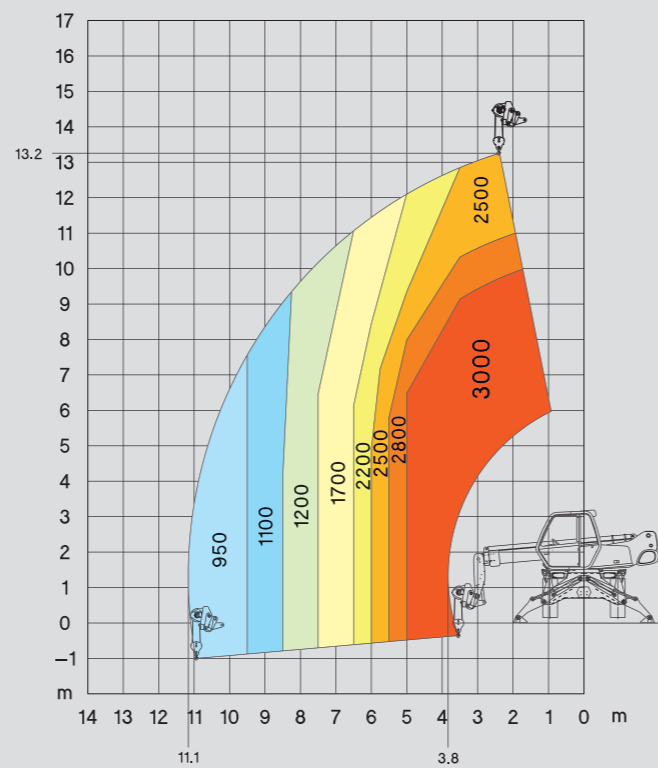

ROTATION ON STABILISERS WITH 365 KG PLATFORM ORH - 2/4 m

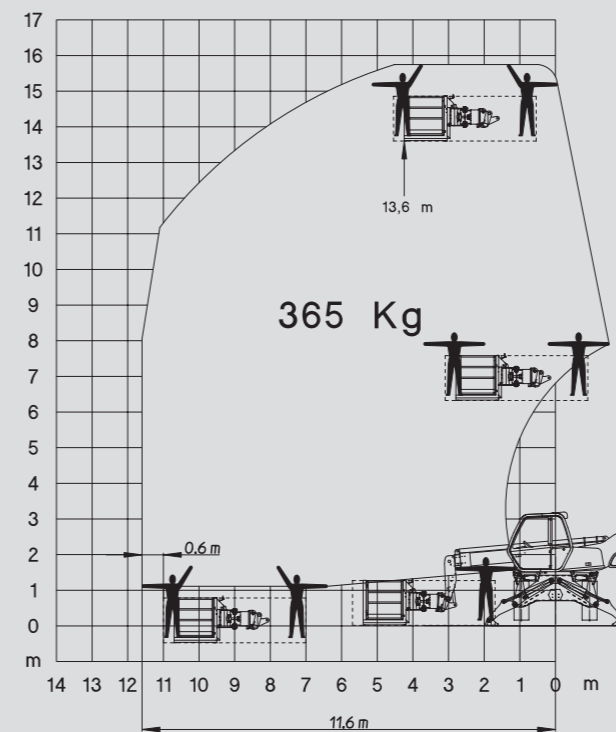

ROTATION ON STABILISERS WITH 1000 KG PLATFORM ORH - 2/4 m

